



CORNTROL



A new advance in multi-intelligent control systems  
- user manual -

# index

Wi-Fi firmware released version 1.2.0  
Main firmware released version 0.2.7

1

## USER INTERFACE

- 7 Segment display
- LED Signals
- Error notifications in the 7-Segment display

3

## FUNCTION

- Temperature display
- Compressor operation
- Cooling fan coil operation
- Defrosting
- Notification of exceeding/dropping below temperature limit
- Protection against excessively high/low voltage
- Door status check
- Wi-Fi connection and recording of information in The Cloud
- Firmware updates using OTA system
- Sound settings
- Warning/notification light operation (Relay 4)
- Power On/Off lock settings

8

## PARAMETER SETTING

- Settings and parameters (User level)
- Settings and parameters (Advanced level)
- Parameter table for entire system

13

## HARDWARE SPECIFICATION

- Mounting size (mm)
- Output relays
- Temperature sensor probe
- Wiring diagram

14

## CORNTROL SOFTWARE

- How to connect device

16

## WARRANTY

- Registration for warranty

Please scan this QR code to  
access the Thai user manual.









# IoT Digital Controller Alpha I









## (7-Segment display)



- Selecting Probe 1 allows user to display temperatures from -40.0 to +85.0 (in cases where Offset is 0.0) with an accuracy of  $\pm 1.0^{\circ}\text{C}$
- Selecting Probe 2 allows user to display temperatures from -30.0 to +99.9 (in cases where Offset is 0.0) with an accuracy of  $\pm 1.0^{\circ}\text{C}$
- Displayed in increments of  $0.1^{\circ}\text{C}$  /step

LED Signals and their meanings			
Component/ Function	Signal		Meaning
Compressor		Illuminated	Compressor is operational
		Flashing intermittently	Compressor is currently non-operational/preparing to operate
Fan Coil		Illuminated	Fan Coil is operational
		Flashing intermittently	Fan coil is currently non-operational/ preparing to operate
Defrost		Illuminated	Defrosting
		Flashing intermittently	Defrosting not currently possible due to incorrect settings
Light		Illuminated	Light is on
Wi-Fi		Illuminated	Connection to both the cloud and the router is functional
		Flashing once	Connection to the router is not currently working
		Flashing twice	The connection to the router is functional, but the connection to the cloud is currently not working
		Not illuminated	Wi-Fi currently off
Alarm		Flashing intermittently	Notification of error

- Table 1.1 -



TOUCH BUTTON SWITCH			
Button		Action	Resulting command
Power		Press and hold for 2 seconds	Turns device on/off
Light		Press once	Turns light on/off
Defrost		Press and hold for 3 seconds	Turns manual defrost on/off
Setting		Press and hold for 3 seconds	Enter/exit User Settings menu
		Press and hold for 5 seconds	Enter Advanced Settings menu (hold again for 5 seconds to exit)
		Press once	Ok/Turn off alarm
Up		Press once	Toggle/adjust setting
		Press and hold for 5 seconds while device is switched off	Enter AP Mode
Down		Press once	Toggle/adjust setting

- Table 1.2 -

- The  button can be pressed while the device is active or switched off.
- The  button can be pressed and held for either 3 or 5 seconds to access the settings menus regardless of whether the device is active or switched off.
- When the device registers a command from a button press it will respond a single beep and vibration from the buzzer.

ERROR NOTIFICATION FOR 7-SEGMENT		
Display	Cause	Associated Parameters
<b>E0</b>	Sensor Probe 1 faulty or open	-
<b>E1</b>	Sensor Probe 2 faulty or open	-
<b>E2</b>	The recorded parameter has an error or is faulty	-
<b>E3</b>	There is a communication problem between main device system and the device display	-
<b>E4</b>	There is a communication problem between the device display and the Wi-Fi Module	-
<b>tLo</b>	The temperature has dropped below the designated minimum temperature	rA2, A1, AL, Ad
<b>tH1</b>	The temperature has exceeded the designated maximum temperature	rA2, A1, AH, Ad
<b>Lu</b>	The voltage has dropped below the designated minimum voltage	vE, vD, Lo, cd
<b>Hu</b>	The voltage has exceeded the designated maximum voltage	vE, vD, Ho, cd

- Table 1.3 -

- When an error has occurred (except **E3**) a buzzer will sound and beep three times continuously.
- To turn the buzzer off, press  button 1 once.
- When an error has occurred, (**E2**) the user can clear the error by pressing  button 1 once. This will reset all parameters back to their default settings.

# function

## Temperature display

- Users are able to set the temperature display for both Probe 1 and Probe 2 (Parameter/4)
- Users are able to choose between units of °C or °F (Parameter/5)
- When Probe 1's temperature is being displayed, there may be a delay with the display. The display will gradually show the temperature, climbing in increments of 1.0°C (Parameter/2). There will be no delay if the temperature is decreasing, and the display will update immediately.
- There will be a short delay and the system will not display the temperature for 5 seconds in the following cases:
  - When the device is switched on
  - When the device is showing the sensor temperature (for example, after replacing a faulty sensor)
  - When the user exits the parameter setting mode
- Temperature display following defrosting
  - The temperature control system in the refrigerator (Probe 1) cannot exceed the following maximum temperatures:
    - The lowest temperature in the refrigerator (Probe 1) since defrosting commenced
    - The set temperature at which the compressor begins to operate ( $St + rd$ )
  - The system will cancel all limits to the temperature display once the defrosting process is complete, and in accordance with the following conditions:
    - The temperature inside the refrigerator is equal to or lower than the previous limit
    - The device is turned off
- When the delay time for temperature display incrementally rises by every 1.0°C (parameter /2) and is configured as 0, the system will exhibit no delay in presenting elevated temperatures. Additionally, it will not limit the temperature display both during and after the defrosting process
- The delay in displaying higher temperatures will be temporarily disabled for 5 seconds when Probe\_2 is activated through the parameter /A2 during operation.

## Compressor operation

- The compressor will become operational when the temperature inside the refrigerator (Probe 1) is equal to or higher than the value of  $St + rd$
- The compressor will cease operation when the temperature inside the refrigerator (Probe 1) is equal to or lower than the value of  $St$
- When supplying power to the device for the first time, there will be a temporary delay of 00 minutes before the compressor becomes operational. A random 0-31 second delay is also added to prevent issues with multiple devices in the same area. In case of a power outage and restoration, simultaneous compressor activation is avoided to prevent power surges. (The displayed number is randomly generated with each button press.)
- When the compressor ceases to operate there will be a temporary delay of 02 minutes before the compressor becomes operational again
- When the compressor becomes operational, it must remain operational for a minimum of 03 minutes
- In the case of a faulty, broken or non-operational Probe 1 sensor, the compressor will operate according to the parameter 04 , as follows :
  - User sets parameter 04 as 0 = the compressor will cease to be operational
  - User sets parameter 04 as 1-99 = the compressor will be operational for a number of minutes equal to parameter 04 with breaks every 15 minutes
  - User sets parameter 04 as 100 = the compressor will be continuously operational

## Cooling Fan Coil Operation

- The cooling fan coil settings can be adjusted by changing parameter  $F0$ 
  - When  $F0 = 0$  is selected the fan will operate continuously. If  $dr0 = 1$  is selected, the fan will cease to be operational when the door is open.
  - When  $F0 = 1$  is selected the fan coil will operate according to the temperature setting of Probe 2
    - The fan will cease to operate when the temperature of Probe 2  $\geq F1$
    - The fan will become operational when the temperature of Probe 2  $\leq F1 - 1.0$  °C
  - When  $F0 = 2$  is selected, the fan coil will become operational or cease to be operational according to the current state of the compressor.
- The fan coil can be controlled during defrosting by adjusting parameter  $F3$ 
  - When  $F3 = 0$  is selected, the fan coil will be operational during defrosting
  - When  $F3 = 1$  is selected, the fan coil will not be operational during defrosting and will only become operational again after a period of time equal to  $dd + Fd$

## Defrosting

- The defrosting process can be turned on/off by adjusting parameter  $r3$
- Defrosting settings can be changed by adjusting parameter  $df$ 
  - In cases where the defrosting heater ( $df = 0, 2, 4, 5, 7, 9$ ) is set, the compressor will cease to be operational, and the heater will immediately become operational (Relay defrost controlled heater)
  - If you want to defrost by stopping only the compressor's operation, you can select the defrosting pattern as heater ( $df = 0, 2, 4, 5, 7, 9$ ) without the need to connect to an actual heater.
  - In cases where hot gas setting is selected for defrosting ( $df = 1, 3, 6, 8$ ), the reversing valve will be used to send the liquid in the opposite direction (Relay defrost controlled by reversing valve), the compressor will remain operational to aid in reversing the flow of the liquid. In this case the Reversing valve can be switched on/off without affecting the compressor.
- Conditions for beginning defrosting process
  - When user selects  $df = 0, 1, 2, 3, 4$  the system will commence automatic defrosting during the times dictated by parameter  $dl$ , beginning immediately when the device is switched on, or following the previous defrosting process.
  - When user selects  $df = 5, 6, 7, 8, 9$  the system will automatically initiate defrosting process whenever the compressor operates for an accumulated  $dl$  time.
  - Pressing and holding the  button for 3 seconds to immediately start or stop the defrosting process at any time.
- Conditions for stopping the defrosting process
  - When user selects  $df = 0, 1, 5, 6$  the system will stop the defrosting process when
    - The temperature of Probe 2  $\geq dt$  or
    - The defrosting period is  $\geq dp$
  - When user selects  $df = 2, 3, 7, 8$  the system will stop the defrosting process when
    - The duration of the defrosting process  $\geq dp$
- When user selects  $df = 4, 9$  the system will stop the defrosting process when
  - the temperature of Probe 2  $\geq dt$
- Following defrosting, the system will delay the operations of the compressor and evap-fan motor for a period equal to  $dd$  and following this, the evap-fan motor for an additional period equal to  $Fd$ .
- In cases where heat is provided by hot gas, the system will count the duration of the defrosting period from when the compressor becomes operational.
- If the device is switched off or Probe 1 or Probe 2 are faulty, the system will cancel the defrosting process and immediately begin a new process when the device is switched on again.

## Notification of exceeding/dropping below temperature limit

- The temperature range setting, maximum and minimum temperatures and resulting notifications can be set on the device.
- The maximum and minimum temperatures are dictated by parameter  $\text{rR2}$  and
  - When the user selects  $\text{rR2} = 0$ , the temperature of Probe 1 will be used as a benchmark
  - When the user selects  $\text{rR2} = 1$ , the temperature of Probe 2 will be used as a benchmark
- The maximum temperature can be set at parameter  $\text{RH}$  and the minimum temperature and the minimum temperature at parameter  $\text{RL}$
- The value of  $\text{RH/RL}$  can be set at  $\text{R1}$ , as follows
  - When  $\text{R1} = 0$  is selected, there will be notifications when :
    - The benchmark temperature  $< \text{SE} - \text{RL}$  or
    - The benchmark temperature  $> \text{SE} + \text{RH}$  continuously over the set delay time for notification.
  - Note: The settings for  $\text{RH}$  and  $\text{RL}$  must be greater than or equal to 0. If the settings are configured to be less than 0, invert the sign and apply both addition and subtraction in the above equation.
  - When  $\text{R1} = 1$  is selected, there will be notifications when :
    - The benchmark temperature  $< \text{RL}$  or
    - The benchmark temperature  $> \text{RH}$  continuously over the set delay time for notification.
- Adjust notification delay when the temperature goes beyond the set range using CORNTROL SOFTWARE
  - Usage time range: 0 seconds – 60 minutes (Default 2 seconds)
- The system will cancel the notification when the benchmark temperature exceeds the minimum temperature or falls below the maximum temperature by a margin equal to  $\text{RD}$
- When the temperature falls below the minimum temperature  $\text{EL0}$ , the notification will flash the current temperature and an alarm will sound.
- When the temperature exceeds the set maximum temperature  $\text{EH1}$ , the notification will flash the current temperature and an alarm will sound.
- During the defrosting process, the system will cease to carry out temperature checks and all related notifications until the process is completed. When the temperature has returned to within the designated temperature range for  $\text{RD}$  minutes, the checks will begin again.
- There will be a delay in notifications equal to  $\text{RD}$  minutes when:
  - Commencing when power is turned on to start operating.
  - When the defrosting cycle is completed and the compressor starts cooling.
- If the temperature returns to the set range earlier than the  $\text{RD}$  time, the notification alarm will resume monitoring.
- While the device is off, the system will not check the temperature limits, and there will be no alert if the temperature exceeds the limits.



## Protection against excessively high/low voltage

- The protection can be switched on/off by adjusting parameter  $\text{VE}$
- The minimum voltage limit can be set by adjusting parameter  $\text{L0}$
- The maximum voltage limit can be set by adjusting parameter  $\text{H0}$
- When the system detects a voltage level that exceeds  $\text{H0}$  for a duration of  $\text{CD}$  seconds, the system will shut off the compressor, the  $\text{HU}$  display will flash and an alarm will sound.
- When the system detects a voltage level that falls below  $\text{L0}$  for a duration of  $\text{CD}$  seconds, the system will shut off the compressor, the  $\text{LU}$  display will flash and an alarm will sound.
- The system will cancel all notifications and allow the compressor to become operations when the voltage levels falls below  $\text{H0} - \text{UH}$  or rises above  $\text{L0} + \text{UH}$
- The current voltage level (Vrms) can be viewed at parameter  $\text{U0}$
- The electric power value (Pavg) can be viewed at parameter  $\text{U1}$  The system gives readings up to 2,000W and when the watt level exceeds 999, the result will be displayed in units of kw (kilowatt) with a decimal point behind the first digit.
- The current value (Irms) is visible at parameter  $\text{U2}$ , shown with two decimal places. If the current value surpasses 9.99A, the display will switch to one decimal point.
- The voltage, power and readable current values may be marginally inaccurate (+- 5%)

## Door status check

- The door status check can be activated/deactivated by altering parameter  $dr0$
- The type of sensor used in the door status check can be selected by altering parameter  $dr1$ 
  - If  $dr1 = 0$  is selected, the door opens when the sensor closes the circuit
  - If  $dr1 = 1$  is selected, the door opens when the sensor opens the circuit
- If  $F0 = 0$  is selected and the door status check is operational, the fan coil will cease to be operational
- When the door is opened the door status check can be done by viewing parameter  $dr2$

## Wi-Fi connection and recording of information in the cloud



- The Wi-Fi connection can be turned on/off by adjusting parameter  $nEt$  (the connection only works for 2.4 GHz connections)
- Press and hold the  button for 5 seconds while the device is switched off to enter AP mode. The screen will display AP, and the system will turn on the internal Wi-Fi signal with the SSID: CORNTROL\_XXXXXX (XXXXXX representing the last six digits of the device's MAC address). Users can connect to the Wi-Fi by entering the password: 1234567890.
- When the device has entered AP mode, the system will automatically commence the Wi-Fi scan and will continue to scan and update at intervals of five minutes
- When connected to the router, the signal strength can be checked at parameter  $5n5$
- The Wi-Fi signal strength can be checked by viewing the  light (for further details consult table 1.1)
- The interval for the sending of data to the cloud can be set to 1, 5 or 10 minutes (default setting is 5 minutes) and the system will send the information as follows

1. Date and time of data collection	5. Defrosting status	10. Power electric value
2. Wi-Fi connection status	6. Light status	11. Irms value
3. On/off status of refrigerator/ freezer	7. Compressor on/off status	12. Probe 1 temperature
4. Door status	8. Evap- fan motor on/off status	13. Probe 2 temperature
	9. Voltage value	14. Wi-Fi signal strength

- In cases where the internet connection is lost or the system is unable to connect to the cloud, the system will keep any data and system changes in the device and upload them to the cloud immediately once the connection is resumed. The system is able to retain information for a period of up to 48 hours recorded at the intervals set in the device settings.
- In cases where 48 hours has elapsed and the device still cannot connect to the internet or cloud, the information contained in the device will be automatically recorded.
- If the user sets the parameter  $nEt = 0$ , any information in the device will not be stored in the memory.
- The date and time settings sent with the cloud upload are taken from the Internet (SNTP Server). In cases where the system cannot connect to this server, the data will be recorded according to the RTC (Real Time Clock).
- In cases where the system is unable to record the time setting from any source (No internet connection and the RTC battery has expired), the system will use System Time as a replacement to report the time. The time begins counting from 00:00:00, January 1st, 1970 and using Unix as a standard.
- The device is able to receive commands and settings through the CONTROL Software and will emit two short beeps when the command has been successful. (In cases where the device does not respond to a command, check the sound settings menu in the application)



## Firmware updates using OTA system

- The OTA system can only be started when the device is connected to the internet.
- Firmware can be updated using CORNTROL Software.
- The two components which are available for firmware updates through the OTA system are the main system and Wi-Fi modules.
- If the system detects firmware updates for main system and Wi-Fi modules in the cloud server, it will first update the main module and only being the Wi-Fi module update when the main module has been successfully updated.
- Once the OTA for the main module has received a command from the system it will commence the firmware update and the display will show  for approximately 2 seconds before switching to an update progress display (from 0-944)
- When the main module is in OTA mode, the system will shut off all relay operations for safety
- If the update to the main module is unsuccessful for any reason, the update process will restart. If the process fails three times, the device will reset to default factory firmware.
- The OTA process for the Wi-Fi module is identical to the main module but the display will show the  symbol for a duration of 5 seconds to notify the user before the Wi-Fi module resets.

## Sound Settings

- The notification sounds that confirm a received command can be switched on/off using the application. Choose the sound settings menu > notification sound from application
- Warning and notification sounds can also be switched on/off through the application settings. Enter the sound settings menu in your device > notification sounds
  - When notification sounds are switched on and active, the time duration of the notification sound can be set to either 5, 10, 20, 30, 40, 50 or 60 seconds.

## Notification Lighting (Relay 4)

- The user can set notification lighting to illuminate whenever an error has occurred in the system.
- Pressing the light button on the device or turning the lights off/on through the application does not affect the status of the other lights which illuminate the device.
- The screen lighting on both device and application will not be lit when notification lighting is activated.
- The notification lighting settings can only be accessed and altered through the application.

## Power On/Off Settings and Lockout

- The power on/off settings and button lockout can only be accessed through the application.
- The button lock settings can be accessed through Protected Mode > Power Button Lockout.
- In cases where the power button is locked, the message 'LC' will be displayed on the screen to inform the user that lockout is currently activated.
- Should the user wish to reset the settings, instructions can be found in the 'Parameters and Settings (Advanced level)' section.

# parameter setting

## User Parameter Settings

- The user can adjust the settings and view various parameters without using a password by carrying out the following actions:
  - Pressing and holding the **SET** button for 3 seconds until the display shows the selected parameter, the first of which is **5t**
  - Pressing the **SET** button once will allow the user to scroll through the parameters
  - Pressing the **▲** or **▼** buttons will increase/decrease the parameter value
  - Pressing the **SET** button will record the new value. Once it has been recorded the display will return to show the parameter that has been altered
  - Pressing the **▲** or **▼** button to check other parameter values
  - Pressing and holding the **SET** button for a further 3 secs to return to the temperature display
- The parameters which can be viewed or altered are as follows :
  - **5t** Temperature set point value
  - **u0** Vac value
  - **u1** Power electric value (watt)
  - **u2** Electrical current value (Amp)
  - **nEt** Current Wi-Fi connection status
  - **5n5** Current Wi-Fi signal strength
  - **rd** Shows the difference between the temperature set point and the temperature at which the compressor becomes operational

## Advanced Parameter Settings

- These settings can only be accessed by a technician or authorized person with a password
  - Press and hold the **SET** button for 5 seconds. The display will show 0 ready to receive the password
  - Press the **▲** or **▼** buttons to enter the password = 22
  - Press the **SET** button once and the display should show the parameters, the first of which is **rE1**
  - Press the **▲** or **▼** buttons to select the required parameter
  - Press the **SET** button once more and the display should show the current parameter value
  - Press the **▲** or **▼** buttons to change the parameter value
  - Press the **SET** button once to record the new value. Once the new value is recorded the display should return to showing the parameter.
  - Once you have finished editing the required parameters, press and hold the **SET** button for 5 seconds. The display should return to showing the temperature
- The values for all parameters can be reset to their default values by pressing the **⓪** and **SET** buttons together and holding them for 4 seconds until the **dFl** symbol flashes on the display.
- If a parameter value has been adjusted to its maximum/minimum value and cannot be adjusted further, the display will flash 4Hz repeatedly
- If no buttons have been pressed for a total of 60 seconds, the system will automatically exit the parameter setting menu, flashing 4Hz on the screen as a warning prior to exiting.
- You can adjust parameters through the CORNTR0L Software, except for parameters related to Wi-Fi connection

## COMPLETE TABLE OF PARAMETERS

Symbol	Details	Default	Recommended		Range of Operation
			Chiller	Freezer	
<b>Parameters related to temp sensor</b>					
rC1	Adjusts temperature to match Probe 1	0.0°C	0.0°C	0.0°C	-10.0°C to +10.0°C
rC2	Adjusts temperature to match Probe 2	0.0°C	0.0°C	0.0°C	-10.0°C to +10.0°C
r2	Delay value (increasing by 1°C at time)	2 mins/°C	2 mins/°C	2 mins/°C	0 to 10 minutes/°C
rA2	Controls operations of Probe 2	0	0	2	0 = Doesn't require Probe 2 cable 1 = Product probe 2 = Defrost probe
<b>Parameters related to display screen</b>					
r4	Select probe to be displayed	1	1	1	1 = Probe 1 2 = Probe 2
r5	Selects display unit	0	0	0	0 = °C 1 = °F
<b>Control Parameters</b>					
SE	Temperature setpoint value	0.0°C	2.0°C	-18.0°C	r1 to r2 °C
r1	Minimum possible setpoint	-40.0°C	1.0°C	-25.0°C	-40.0°C to r2°C
r2	Maximum possible setpoint	40.0°C	10.0°C	0.0°C	r1 to 40.0°C
r3	Defrosting/no defrosting	0	0	0	0 = defrosting 1 = no defrosting
rd	Sets the difference between the temperature set point and the temperature at which the compressor becomes operational	5.0°C	5.0°C	5.0°C	0.0°C to 20.0°C
C4	Sets the operation time for the compressor in the case of faulty/non-functioning Probe 1	0	0	0	0 = compressor ceases operation 1 - 99 = allow the compressor to operate for C4 alternating with 15 minute rests 100 = compressor is constantly operational
<b>Compressor protection parameters</b>					
C0	Sets the compressor delay for when is turned on	0	2	2	0 - 100 minutes
C2	Sets the minimum time period for the compressor to cease operation	0	3	5	0 - 100 minutes
C3	Sets the minimum compressor operating period for each start	0	0	0	0 - 100 minutes

Symbol	Details	Default	Recommended		Range of Operation
			Chiller	Freezer	
<b>Defrosting parameters</b>					
<b>d0</b>	Defrosting mode 0,1,4,5,6,9 (Can only be selected when $rR2 = 2$ )	0	2	0	<p>0-4 = <b>dL</b> The distance of defrosting each time, and it occurs at regular intervals:</p> <ul style="list-style-type: none"> <li>• 0: Heater/Cancel based on temperature Probe 2 and not less than the specified time</li> <li>• 1: Hot gas/Cancel based on temperature Probe 2 and not less than the specified time</li> <li>• 2: Heater/Cancel based on time</li> <li>• 3: Hot gas/Cancel based on time</li> <li>• 4: Heater/Cancel based on temperature Probe 2</li> </ul> <p>5-9 = <b>dL</b> Each time defrost occurs, when the compressor operates accumulatively for:</p> <ul style="list-style-type: none"> <li>• 5: Heater/Cancel based on temperature Probe 2 and not less than the specified time</li> <li>• 6: Hot gas/Cancel based on temperature Probe 2 and not less than the specified time</li> <li>• 7: Heater/Cancel based on time</li> <li>• 8: Hot gas/Cancel based on time</li> <li>• 9: Heater/Cancel based on temperature Probe 2</li> </ul>
<b>dL</b>	The time interval for defrost each time is constant when (if) it is = <b>dL</b> • (When <b>d0</b> = 0-4)  Defrost occurs each time when the compressor operates for an accumulated time = <b>dL</b> • (When <b>d0</b> = 5-9)	8	5	6	1 - 168 hours
<b>dt</b>	Temperature at which defrost process ceases ( <b>d0</b> = 0, 1, 4, 5, 6, 9)	0.0°C	8.0°C	8.0°C	-30.0°C to 99.9°C
<b>dP</b>	Maximum defrost duration ( <b>d0</b> = 0-3, 5-8)	30	15	25	1 - 60 minutes
<b>dd</b>	Compressor and evap-fan motor delay for defrosting process	0	0	2	0 - 15 minutes

Symbol	Details	Default	Recommended		Range of Operation
			Chiller	Freezer	
<b>Fan Coil Parameters</b>					
<b>F0</b>	Evap-fan motor mode	0	0	0	<ul style="list-style-type: none"> <li>0 = Evap-fan motor operates constantly or according to door status if <math>dr0 = 1</math></li> <li>1 = Fan operates based on the temperature of Probe 2</li> <li>2 = Fan operates based on the operation of the compressor</li> <li>3 = Fan operates based on the temperature of Probe 2 and works according to the status of the door if <math>dr0 = 1</math></li> </ul>
<b>F1</b>	<ul style="list-style-type: none"> <li>Evap-fan motor control temperature ( <math>F0 = 1, 3</math> )</li> <li>When Probe 2 temperature is <math>\leq F1 - 1.0^{\circ}\text{C}</math> The evap-fan motor is operational</li> <li>When Probe 2 temperature is <math>\geq F1</math> the evap-fan motor ceases operation</li> </ul>	0.0°C	0.0°C	0.0°C	-30.0°C to 40.0°C
<b>F3</b>	Controls evap-fan motor during defrosting	1	0	1	<ul style="list-style-type: none"> <li>0 = Evap-fan motor is operational during defrosting</li> <li>1 = Evap-fan motor ceases operation during defrosting</li> </ul>
<b>Fd</b>	Sets delay time for evap-fan motor following <b>dd</b>	0	2	2	0 - 15 minutes
<b>Parameters for protection against excessively high/low voltage</b>					
<b>vE</b>	Turn protection on/off	1	1	1	0 = protection off 1 = protection on
<b>Lo</b>	Minimum voltage at which compressor ceases operation	190	190	190	160 - 270 Vac
<b>Ho</b>	Maximum voltage at which compressor ceases operation	250	250	250	160 - 270 Vac
<b>vh</b>	Margin at which compressor recommences operation	5	5	5	1 - 20 Vac
<b>cd</b>	Duration for which voltage exceeds <b>Ho/Lo</b> minimum/maximum before the compressor ceases operation	5	5	5	0 - 60 seconds
<b>v0</b>	Displays the current Vac reading	-	-	-	150 - 280 Vac
<b>v1</b>	Displays the reading of the electric power value	-	-	-	0 - 999 Watt For readings exceeding 999 Watt, the result will be displayed in Kw
<b>v2</b>	Shows current reading	-	-	-	0.00 - 20.00 Amp

Symbol	Details	Default	Recommended		Range of Operation
			Chiller	Freezer	
<b>Parameters for excessive temperature notifications</b>					
<b>RD</b>	Temperature margin for cancellation of notifications	2.0°C	2.0°C	2.0°C	0.0°C - 20.0°C
<b>RI</b>	Define the value of <b>RL/AH</b>	1	1	1	<ul style="list-style-type: none"> <li>0 = <b>RL/AH</b> is the difference from setpoint</li> <li>1 = <b>RL/AH</b> is the true temperature reading</li> </ul>
<b>RL</b>	Minimum temperature (difference or real value according to <b>RI</b> )	2.0°C	2.0°C	2.0°C	-30.0°C to 85.0°C
<b>AH</b>	Maximum temperature (difference or real value according to <b>RI</b> )	8.0°C	8.0°C	8.0°C	-30.0°C to 85.0°C
<b>Ad</b>	Delay period for notification when: <ul style="list-style-type: none"> <li>Power on</li> <li>After the defrosting process is finished and the compressor starts cooling.</li> </ul>	90	90	90	0 - 250 minutes
	Delay period for notification when Error related to <b>ELo</b> or <b>EH</b> temperature value occurs.  * Setting can only be adjusted via CORNTROL software	2 secs	2 secs	2 secs	0 - 60 seconds
<b>Door Parameters</b>					
<b>dr0</b>	Activate/deactivate door status check (if <b>FD</b> = 0, 3 the fan coil will activate when the door is opened)	1	1	1	0 = Off 1 = On
<b>dr1</b>	Select sensor mode for door status check	0	0	0	0 = Door opens when the sensor closes the circuit 1 = Door opens when the sensor opens the circuit
<b>dr2</b>	Current door status display	-	-	-	0 = Closed 1 = Open
<b>Wi-Fi Parameters</b>					
<b>nEt</b>	Turns Wi-Fi connection on/off (The device will not record information if the connection is not turned on)	1	1	1	0 = Wi-Fi off 1 = Wi-Fi on
<b>Sns</b>	Displays Wi-Fi signal strength (in dbm)	-	-	-	0 - 99 dbm (0 = router not yet connected)

# hardware specification

## Mounting size (mm)

### Display

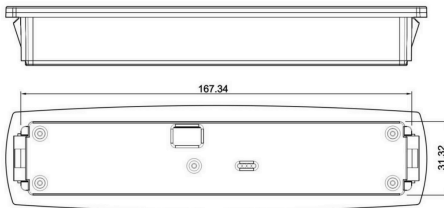

### Main

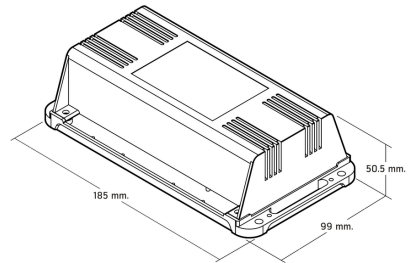

## Output relays

- Compressor 30A / 250VAC
- Fan Coil 7A / 250VAC
- Defrost 7A / 250VAC
- Light 7A / 250VAC

## Temperature sensor probe

- Probe 1 Temp range -40.0°C - 85.0°C 1.5 meter length
  - Length: 1.5 meters, Wire Size: 26 AWG
  - (NTC 2.0kohm at 25.0°C)
- Probe 2 Temp range - 30.0°C - 99.9°C 1 meter length
  - Length: 1.0 meters, Wire Size: 26 AWG
  - (NTC 6.8kohm at 25.0°C)

## Wiring diagram

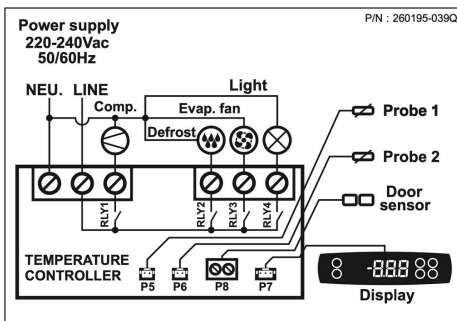

**Note:** The probe accepts cables of up to 10 metres in length. In cases where cables exceed 10 metres, the temperature reading may be affected.

# CORNTROL SOFTWARE

How to connect the device

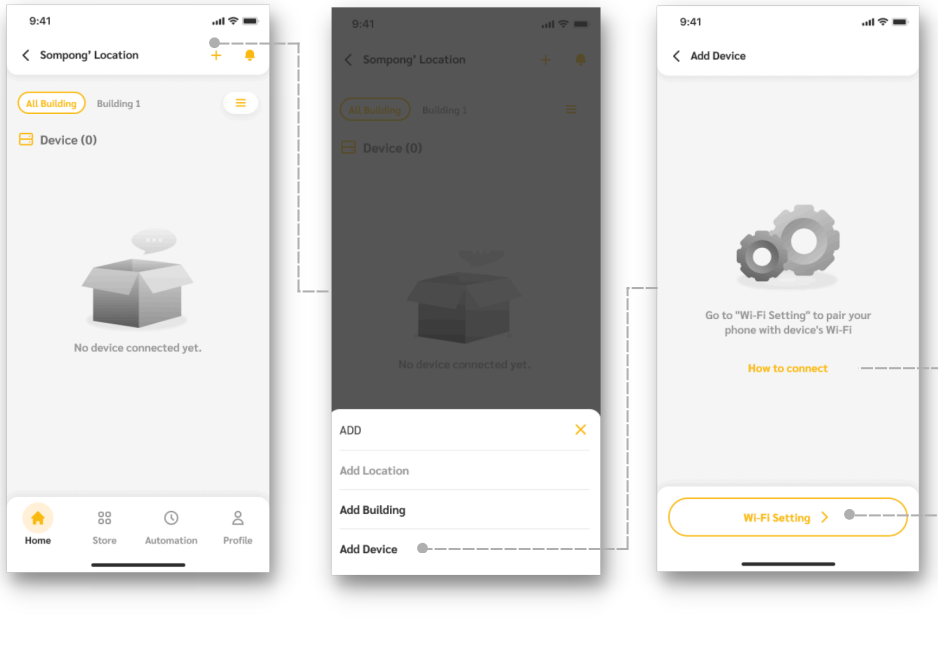

## How to connect Digital Controller

1. With the device switched off, press and hold the  $\wedge$  button for 5 seconds to enter AP mode
2. The device will automatically release the Wi-Fi signal [CORNTROL\_XXXXXX] is the MAC address (XXXXXX being the last 6 digits of the device number)

## Mobile Setting

1. Press the 'Wi-Fi settings' button to connect your phone to the device's Wi-Fi
2. Choose the Wi-Fi connection [CORNTROL\_XXXXXX]
3. Enter the password 1234567890
4. Return to the CORNTROL application to continue



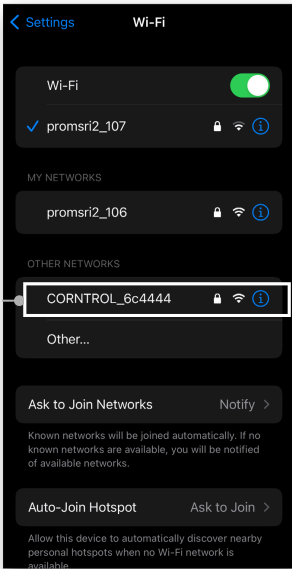

Device Wi-Fi Settings

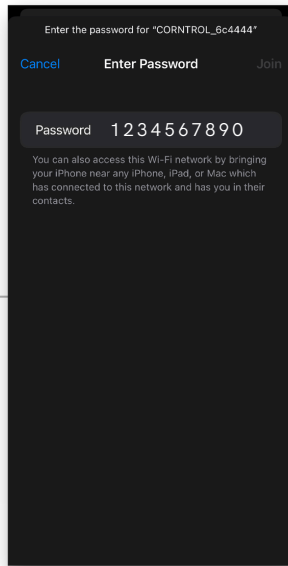

Select Device Wi-Fi and enter password

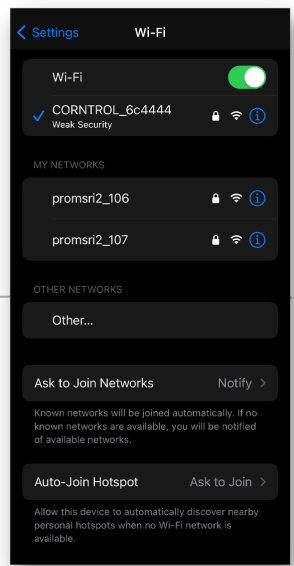

Connect

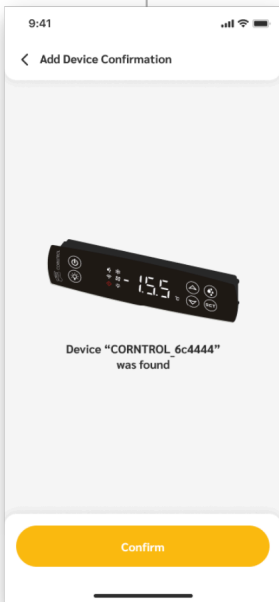

Return to CORNTROL App

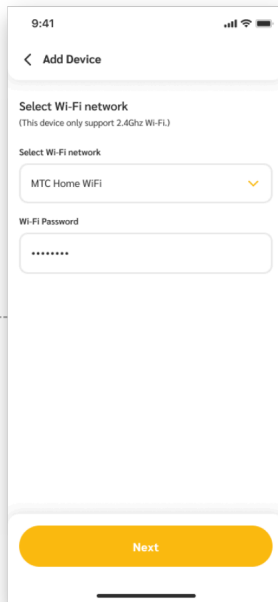

Select Wi-Fi and enter password

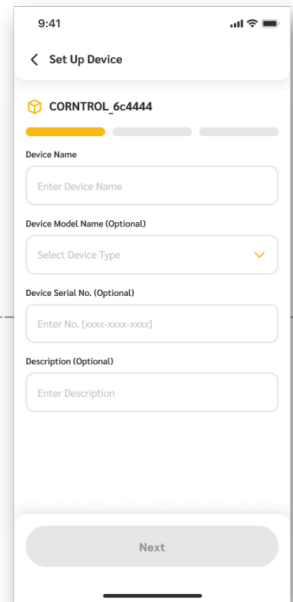

Device Settings

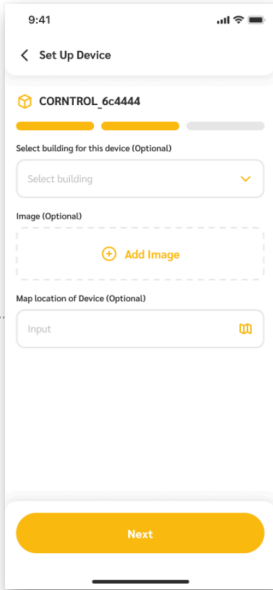

Device Settings

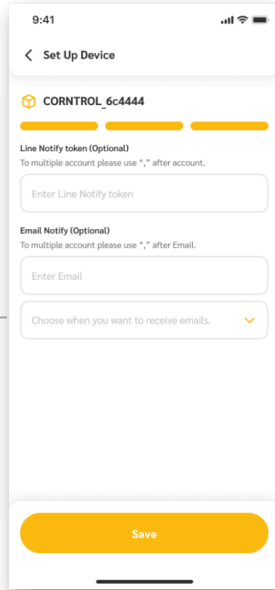

Equipment Settings

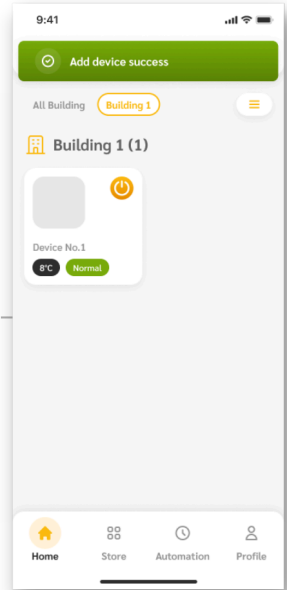

Successful addition of equipment

**NOTE:**

When the device has been connected to a phone, the illuminated  symbol will show that the connection has been established and the device is ready to use.

**WARRANTY:**

1. Add friends on Line OA @corntrol. and send the following details via chat for warranty registration:
  - a. Mac Address (as a photo)
  - b. Serial No. (as a photo)
  - c. Name, Surname, Contact Number, Email.
  - d. If purchased under a legal entity, please specify the company name.
2. The warranty is valid for 1 year from the order date. Please ensure the registration is completed in full, and using accurate information. \* We reserve the right to void the warranty if the information is incomplete, incorrect, or registered more than 30 days after the purchase date.

Please scan QR code to download CORNTROL application

